



# Wi-Fi Module

## User manual

# CONTENT

## 1 User Manual Information

- 1.1 Copyright Statement
- 1.2 About Manual
- 1.3 Target Group
- 1.4 Guideline

## 2 Description

## 3 Operation

- 3.1 Connecting Wi-Fi Module with Inverter
- 3.2 Setting of Wi-Fi Module
- 3.3 Registering the Wi-Fi Module

## 4 Maintenance

- 4.1 Administrator Setting
- 4.2 Restart Module
- 4.3 Load Default
- 4.4 Firmware Update

## 5 Contact

# 1 User Manual Information

## 1.1 Copyright Statement

Copyright © 2012 Shenzhen Growatt New Energy Co.,Ltd, hereinafter referred to as 'Growatt'. All right reserved. No part of this document may be reproduced, stored in a retrieval system, or transmitted, in any form or by any means, electronic, mechanical, photographic, magnetic or otherwise, without the prior written permission of Growatt New Energy. All infringement reserved.

Copyright No. is G1.0. Growatt reserved the final right of interpretation of this manual. The product parameters, appearances and packages are subject to change without notice. Readers are cautioned, however, that Growatt reserves the right to make changes without notice and shall not be responsible for any damages, including indirect, incidental or consequential damages, caused by reliance on the material presented.

## 1.2 About Manual

Distinguished users, thank you very much for your trust in our Wi-Fi Module product, which is developed and manufactured by our R&D department. We sincerely hope it can satisfy your need, also, we're glad to receive your suggestions on improving our product. The target of the manual is to provide the detailed product information, installation, operation and maintenance.

## 1.3 Target Group

The user manual is applied for technicians and common users to operate and maintain the Wi-Fi Module. The readers should be acquainted with some computer network knowledge and operating skill.

## 1.4 Guideline

Before using the Wi-Fi Module, please read the manual carefully. In the meantime, please keep it well, lest maintenance staff may couldn't find it later. All the content, pictures, logos, symbols are reserved. No part of this document may be transmitted in any form without the prior written permission of our internal staff. The content of manual could be changed. Every attempt has been made to make this document complete, accurate and up-to-date. If there are any differences between the contents of the instruction and the product, please regard the actual one as the truth. You can download the newest version from our website [www.growatt.com](http://www.growatt.com) .

# 2 Description

Wi-Fi Module is a wireless device used to monitor inverter. It transmit the data collected from the inverter to the server via router. User could get access to the inverter data by inquiring the server.

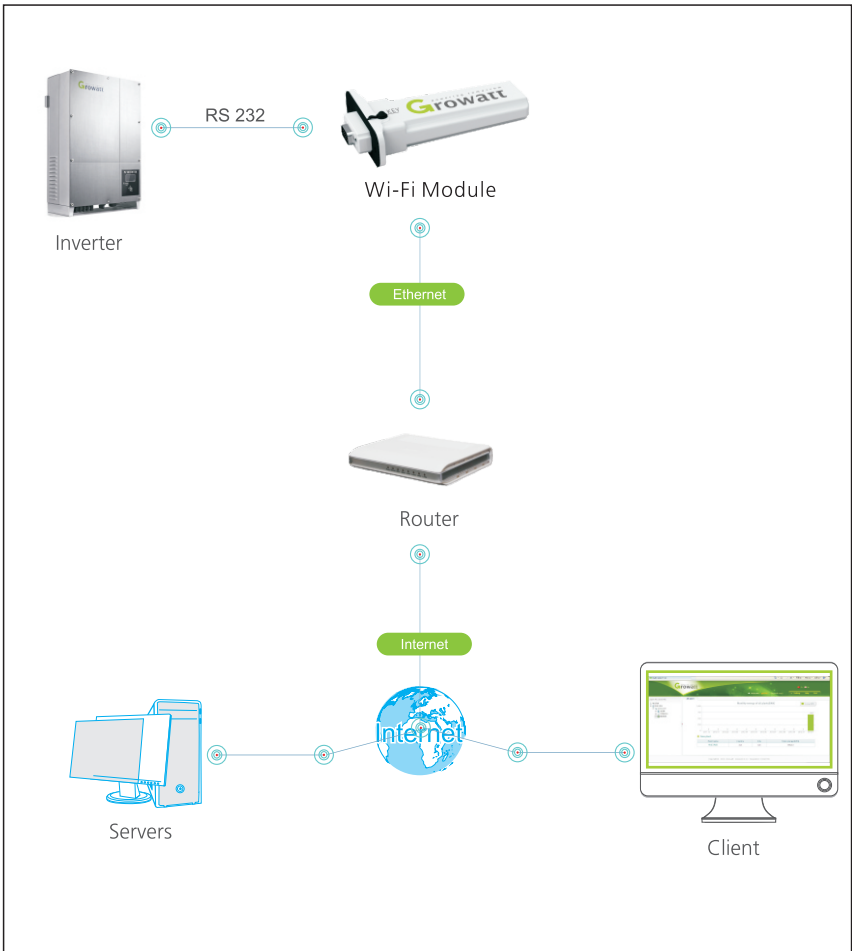

# 3 Operation

## 3.1 Connecting Wi-Fi Module with Inverter

If the RS232 port of Growatt inverter is compliant with the specification (1) as following picture, please plug the Wi-Fi Module to the inverter directly via the RS232 and lock screw.

If the RS232 port is compliant with the specification (2), please pry open the rubber plug in the waterproof cushion, then plug the Wi-Fi Module to the inverter and lock screw.

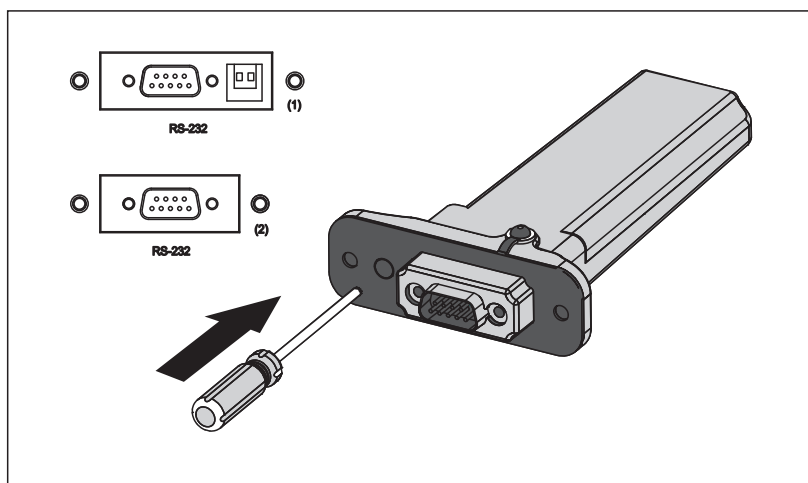

Wi-Fi Module is connected to inverter via RS232. Plug Wi-Fi module into inverter, and lock screw.

## 3.2 Setting of Wi-Fi Module

Wi-Fi Module can be configured via access to Wi-Fi Module IP address.

### 3.2.1 Selecting Wi-Fi Module as wireless network

Choose the wireless network set up by Wi-Fi Module.

**Note:** the computer should contain wireless network adapter.



### 3.2.2 Setting Wi-Fi Module parameters

Start the web browser and enter default IP address "192.168.10.100" of Wi-Fi Module in the address bar. (Note: please set the IP address of computer as obtaining automatically or in the same network segment of "192.168.10.100"). The login interface is shown below (the default user name is admin, and the password is admin).



After login, the interface is shown below

Click on "STA Interface Setting". In the new interface, click on "search".

The searching results are shown below

Site Survey							
	SSID	BSSID	RSSI	Channel	Encryption	Authentication	Network Type
<input type="radio"/>	M3test-000	ac:cf:23:0f:69:c0	0%	1	NONE	OPEN	Infrastructure
<input type="radio"/>	M3test-E01	ac:cf:23:0f:6a:14	100%	1	NONE	OPEN	Infrastructure
<input checked="" type="radio"/>	Ginverter_01	b0:48:7a:3b:a6:42	0%	3	AES	WPA2PSK	Infrastructure
<input type="radio"/>	AH12010002	ac:cf:23:0f:67:e0	10%	3	NONE	OPEN	Infrastructure
<input type="radio"/>	ChinaNet-54BI	ac:6e:1a:73:1d:a4	0%	6	TKIP	WPA2PSK	Infrastructure
<input type="radio"/>	M3test-004	ac:cf:23:f0:62:3c	44%	11	NONE	OPEN	Infrastructure
<input type="radio"/>	2114700037	ac:cf:23:0f:69:34	100%	11	NONE	OPEN	Infrastructure
<input type="radio"/>	TP-LINK_WifiTest	ec:17:2f:b9:e5:4a	44%	11	NONE	OPEN	Infrastructure
<input type="radio"/>	2114700013	ac:cf:23:0f:69:8c	100%	11	AES	WPA2PSK	Infrastructure

Apply Refresh



Select the SSID, Security Mode, Encryption Type, and enter Pass Phrase.

STA Interface Parameters	
AP's SSID	Ginverter_01 <input type="button" value="Search..."/>
MAC Address (Optional)	<input type="text"/>
Security Mode	WP&2PSK <input type="button" value="v"/>
Encryption Type	AES <input type="button" value="v"/>
Pass Phrase(8-32 Characters)	12345678
Connection State	No Setting
<input type="button" value="Apply"/> <input type="button" value="Cancel"/>	

Click on "Apply", the browser jumps to the new interface. Then click on the "restart".

**Set Successfully, Restart to use new setting**

- 
- 
- 
-

The default server address is server.growatt.com. Please confirm the default address is correct.

Network Setting	
Server Address(IP Address or Domain Name)	server.growatt.com
<input type="button" value="Apply"/> <input type="button" value="Cancel"/>	

### 3.2.3 Setting the Network Key of Wi-Fi Module

When Wi-Fi Module gets access to the router, Internet could be available via the wireless network set up by Wi-Fi Module without any permission. User could set the network key to ensure the network security.

**Note:** this operation relates to the network security, you should carry out it to encrypt your network.

Click on the “AP Interface Setting” → choose “Security Mode” and “WPA Algorithms” as following picture → set the “Pass Phrase”, e.g. 12345678.

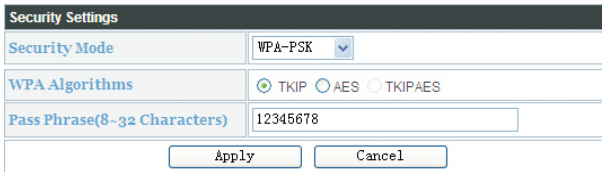

The screenshot shows a window titled "Security Settings" with the following fields and options:

Security Mode	WPA-PSK
WPA Algorithms	<input checked="" type="radio"/> TKIP <input type="radio"/> AES <input type="radio"/> TKIPAES
Pass Phrase(8-32 Characters)	12345678
<input type="button" value="Apply"/> <input type="button" value="Cancel"/>	

After setting, restart the Wi-Fi Module. The network set up by the Wi-Fi Module would be available only after typing in the network key.

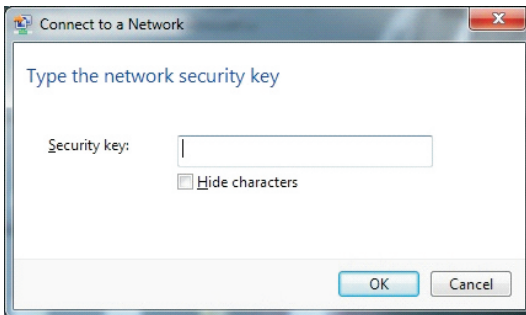

The screenshot shows a dialog box titled "Connect to a Network" with the following content:

Type the network security key

Security key:

Hide characters

### 3.2.4 Acquiring the Serial Number and Check Code

Click on the “System Management”, in “Product Information” field, acquire serial number and check code. When user logs in the Shine server, the serial number and check code are required to register the data logger. After registration, user could check up the inverters’ status via Shine server.

Product Information	
Version	1.0
Serial Number	2114700038
Check Code	3E242

## 3.3 Registering the Wi-Fi Module

### 3.3.1 Registration and login

1. Enter <http://server.growatt.com> in the web browser. If you log in for the first time, please register in advance.



2. Create new account. Please following the prompt, enter the required information.

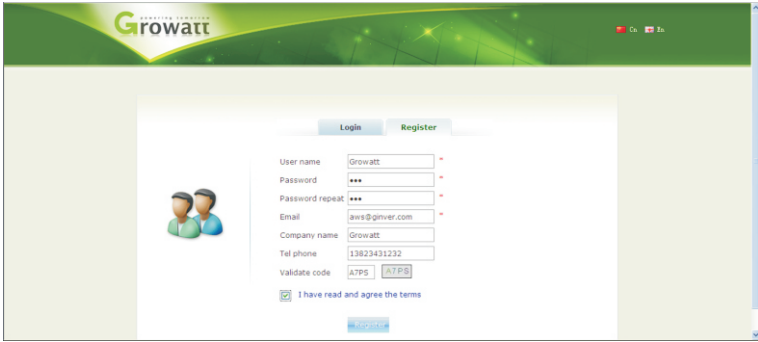

The screenshot shows the Growatt registration page. At the top, there is a green header with the Growatt logo and navigation icons. Below the header, there are two tabs: 'Login' and 'Register'. The 'Register' tab is active. On the left, there is an illustration of two people. The registration form contains the following fields: 'User name' (filled with 'Growatt'), 'Password' (filled with '\*\*\*'), 'Password repeat' (filled with '\*\*\*'), 'Email' (filled with 'aws@gmver.com'), 'Company name' (filled with 'Growatt'), and 'Tel phone' (filled with '13823431232'). There is also a 'Validate code' field with 'ATPS' and 'ATPS' buttons. A checkbox labeled 'I have read and agree the terms' is checked. A 'REGISTER' button is at the bottom.

### 3.3.2 Creating new plant

1. After registration, the web browser jumps to the main interface of Shine Server automatically.

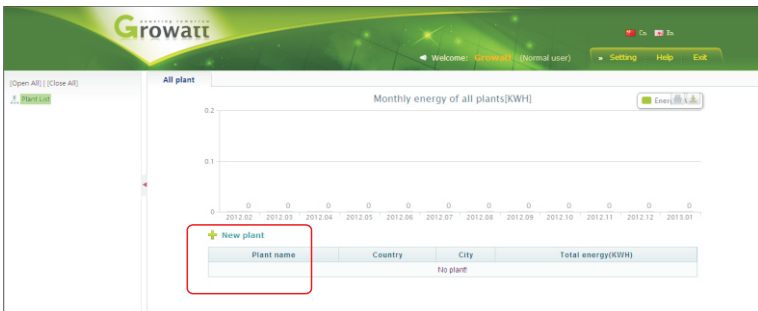

2. Click on "New plant".

The screenshot shows the 'New plant' dialog box in the Growatt software. The form is organized into three sections:

- 1. Set installation info:** Plant name: Growatt, Installation date: 2013-01-05, System power(KW): 1000, Designer: Growatt.
- 2. Set location:** Country: China, City: SZ, Time zone: GMT +8, East longitude: 22° 12' 45", North latitude: 114° 44' 88".
- 3. Set income formula (Set kWh as the conversion standard):** Capital income: 1.20 RMB/Y.

3. Enter the plant information, click on "Save".



### 3.3.3 Adding Wi-Fi Module

1. Click on “Setting”, select “Device management”.

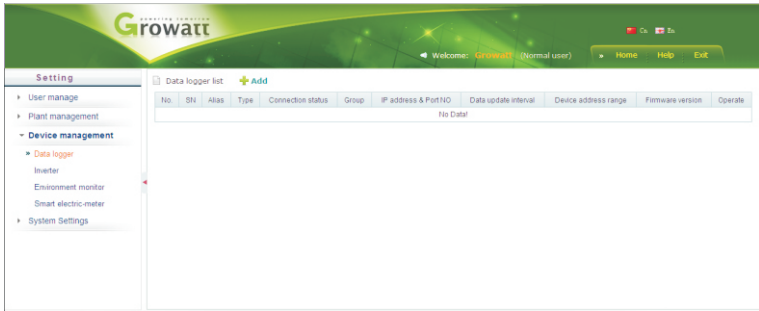

2. Click on “Add” on the right of the setting list.

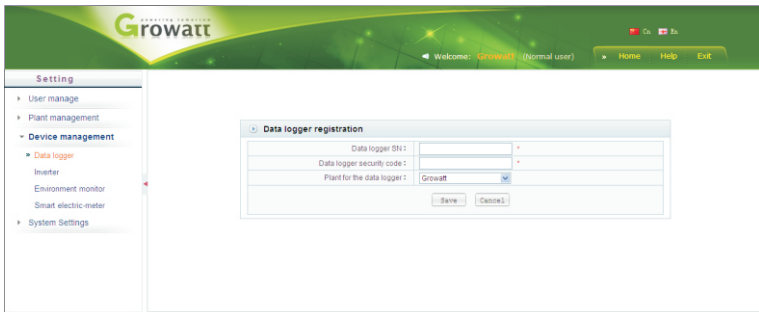

3. Enter the serial number and check number of the Wi-Fi Module. Select the owned plant, then click on “Save”.

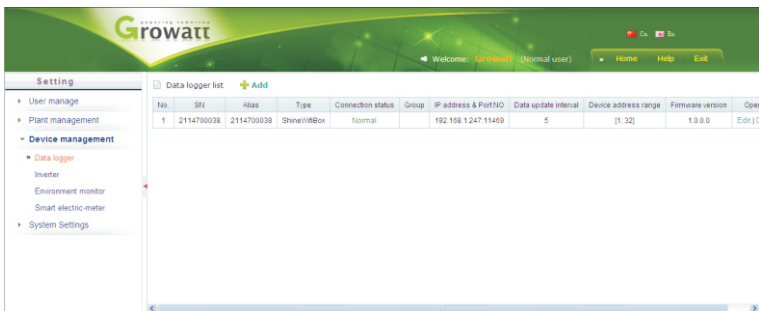

# 4 Maintenance

## 4.1 Administrator setting

The default account and password both are "admin". You can modify them.

Administrator Settings	
Account	<input type="text" value="admin"/>
Password	<input type="text" value="admin"/>
<input type="button" value="Apply"/> <input type="button" value="Cancel"/>	

## 4.2 Restart Module

If the operation of restart is required, please click on "Restart".

Restart System	
Restart System	<input type="button" value="Restart"/>

## 4.3 Load Default

1. If you want to restore the factory setting, please click on "Load Default".

Load Default	
Load Default	<input type="button" value="Load Default"/>

2. You can also restore the factory setting by pressing the "KEY" button for 5 s .  
(Note: the rubber plug should be removed first).

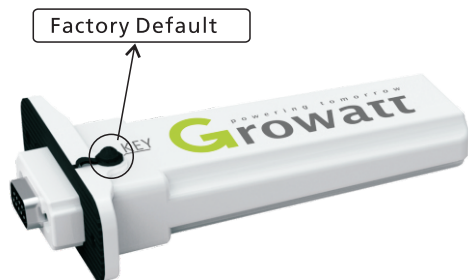

## 4.4 Firmware Update

The update of Wi-Fi Module can be carried out by web operation. Click on "browser", and select the new firmware. Click on "Apply". After updating successfully, the Wi-Fi Module will restart.

Update Firmware	
Location:	<input type="text"/> <a href="#">browse</a>
<input type="button" value="Apply"/>	



# 5 Contact

If you have technical problems concerning our products, please contact Growatt.

Growatt New Energy

Building B, Jiayu Industrial Zone, #28 Guanghui Road, Longteng Community,  
Shiyan, Baoan District, Shenzhen, P.R.China.

[service@ginverter.com](mailto:service@ginverter.com)

[www.growatt.com](http://www.growatt.com)